

排煙用 ELS 型寸法表

選定図は LS 型と同一です

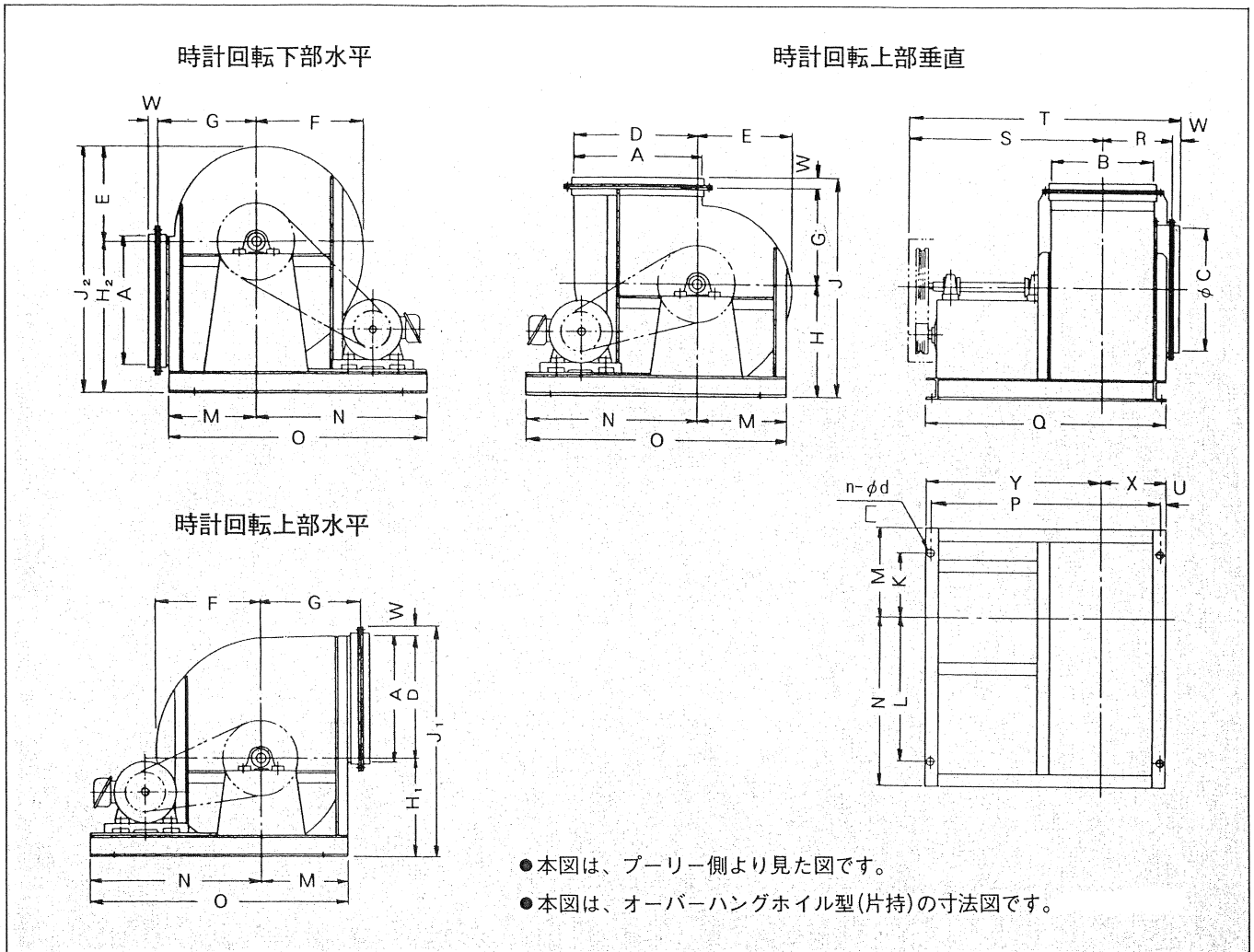

型番	A	B	φC	D	E	F	G	H	H ₁	H ₂	J	J ₁	J ₂	K	L	M	N	O	P	Q	R	S	T	U	W	X	Y	n-φd	□	重量(kg)	
	ESS	ELS																													
# 3	467	355	480	450	337	385	360	410	365	550	800	845	917	220	580	320	680	1000	881	915	238	810	1078	17	30	218	697	4-15	80×40	132	145
3 1/2	543	440	560	525	394	450	400	475	420	625	905	975	1049	260	680	360	780	1140	1046	1080	280	930	1240	17	30	260	820	4-15	80×40	196	220
4	620	500	670	600	446	510	465	535	470	710	1030	1100	1186	325	725	425	825	1250	1116	1150	310	995	1335	17	30	290	860	4-15	80×40	252	280
4 1/2	695	555	760	675	502	574	520	600	530	785	1150	1235	1317	375	775	475	875	1350	1216	1250	338	1040	1408	17	30	318	932	6-15	80×40	330	365
5	780	600	840	760	558	638	585	665	585	890	1290	1385	1488	430	870	530	970	1500	1276	1320	380	1095	1515	22	40	350	970	6-15	100×50	470	520
5 1/2	850	680	900	825	613	701	615	730	645	955	1385	1510	1608	460	940	560	1040	1600	1506	1550	420	1245	1705	22	40	390	1160	6-15	100×50	570	630
6	925	745	1010	900	669	765	670	795	700	1030	1505	1640	1739	515	985	615	1085	1700	1556	1600	453	1270	1745	22	40	423	1177	6-18	100×50	715	850
7	1120	900	1200	1070	781	893	830	930	810	1230	1810	1930	2061	600	1050	750	1200	1950	1740	1800	553	1380	1983	30	50	515	1285	6-18	125×65	902	1080
8	1240	995	1350	1210	892	1020	875	1050	920	1370	1975	2180	2312	660	1090	810	1240	2050	1890	1950	598	1500	2148	30	50	563	1387	6-18	125×65	1320	1580
9	1375	1110	1530	1340	1004	1148	1020	1190	1035	1540	2275	2440	2609	780	1170	930	1320	2250	2030	2100	685	1570	2320	35	65	630	1470	6-18	150×75	1820	2180
10	1520	1200	1700	1500	1115	1275	1120	1310	1160	1700	2495	2725	2880	880	1220	1030	1370	2400	2130	2200	735	1625	2425	35	65	675	1525	6-18	150×75	2340	2800
11	1680	1340	1880	1640	1232	1408	1210	1500	1320	1840	2775	3025	3137	960	1290	1110	1440	2550	2280	2350	827	1705	2597	35	65	745	1605	6-18	150×75	2665	3200
12	1850	1480	2040	1810	1362	1554	1320	1650	1450	2010	3035	3325	3437	970	1380	1220	1630	2850	2510	2580	897	1865	2827	35	65	815	1765	6-18	150×75	3900	4280

(単位: mm)

●モータ重量表

出力(kw)	4極	0.4	0.75	1.5	2.2	3.7	5.5	7.5	11	15	18.5	22	30	37	45	55	75
	6極	—	—	0.75	1.5	2.2	3.7	5.5	7.5	11	15	18.5	22	30	37	45	55
重量(kg)	10.5	14.2	24.4	35.2	43	70	85	115	133	191	211	271	296	350	470		

※重量はモーターベースを
含んだ値です。

リミットロード送風機片吸込LS型

#2LS

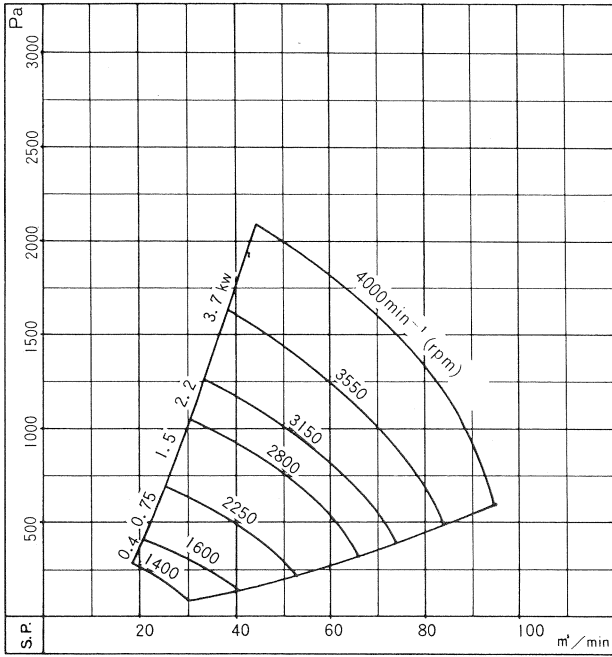

#2½LS

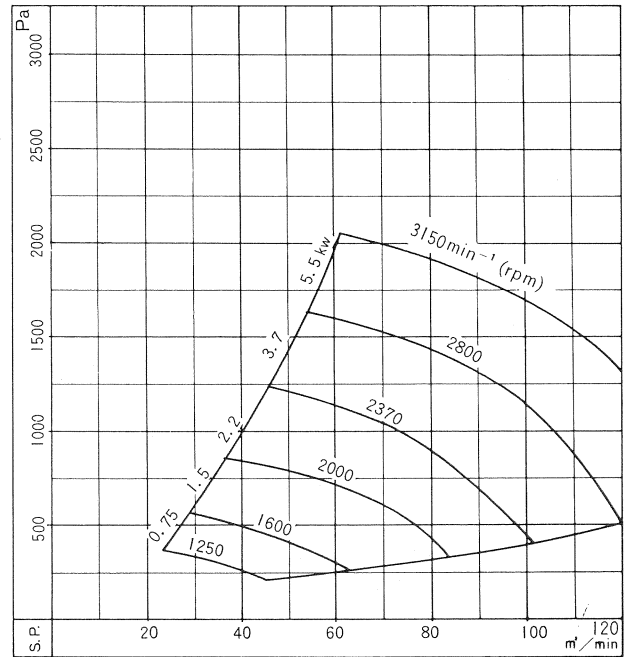

#3LS

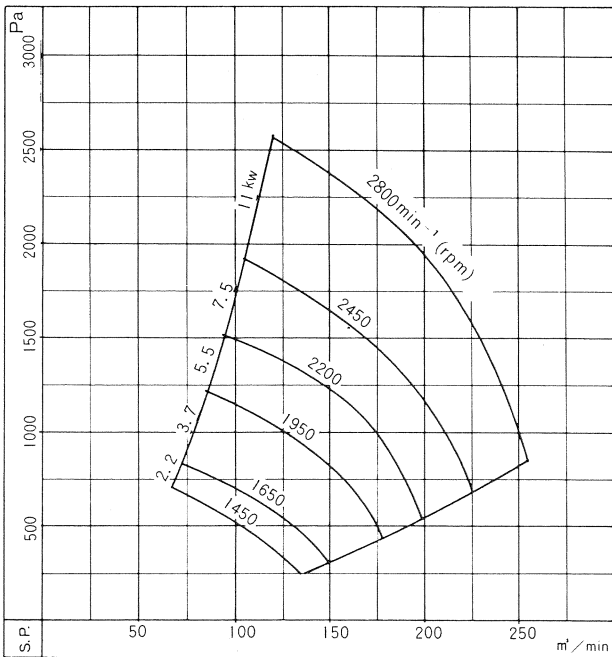

#3½LS

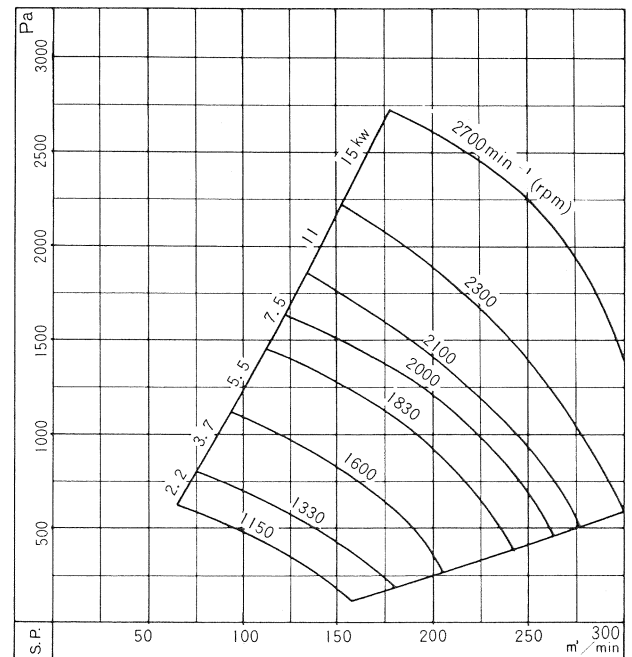

リミットロード送風機片吸込LS型

#4LS

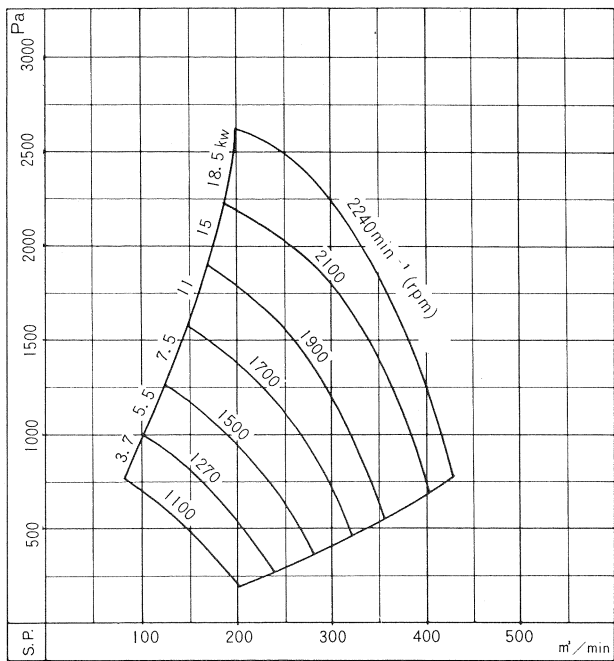

#4 1/2LS

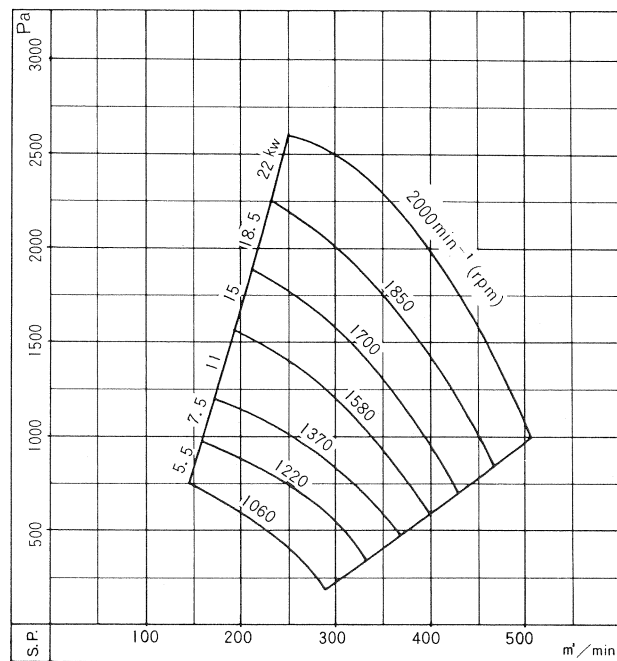

#5LS

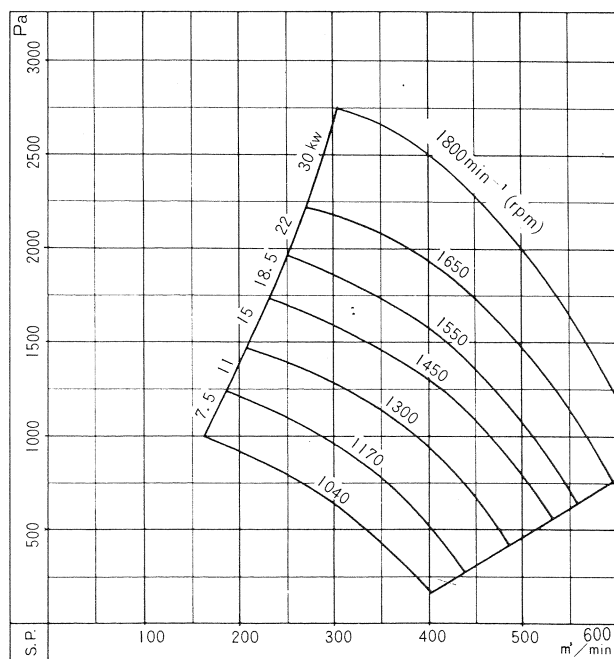

#5 1/2LS

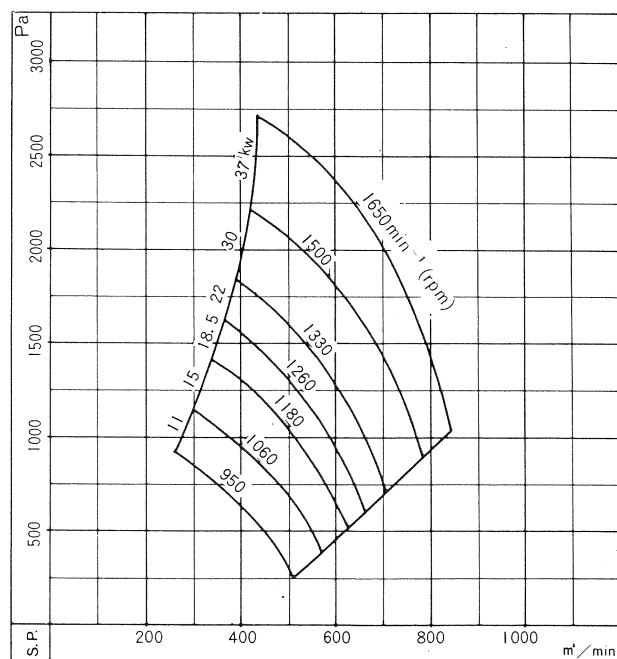

リミットロード送風機片吸込LS型

#6LS

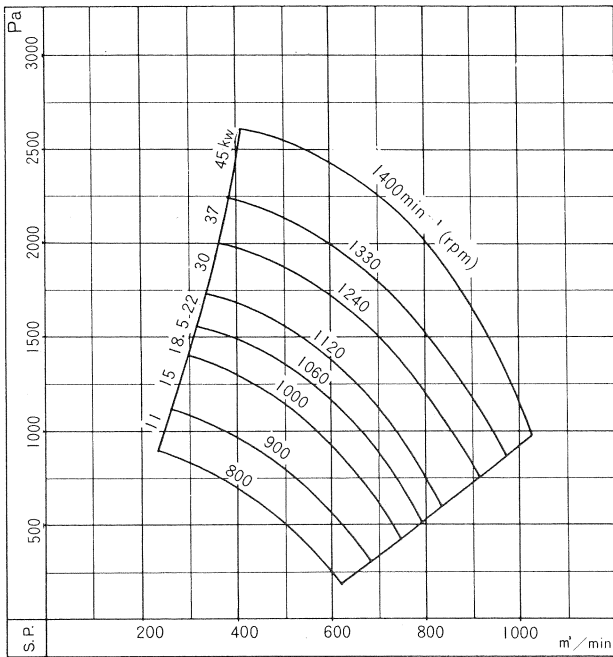

#7LS

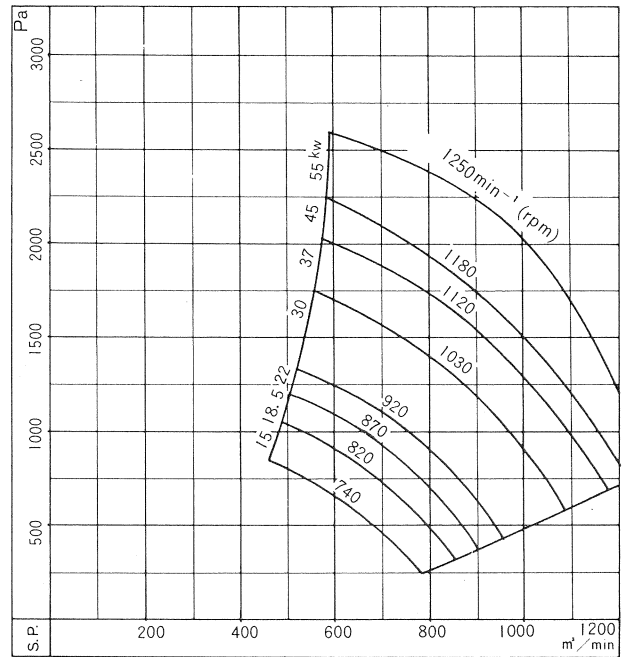

#8LS

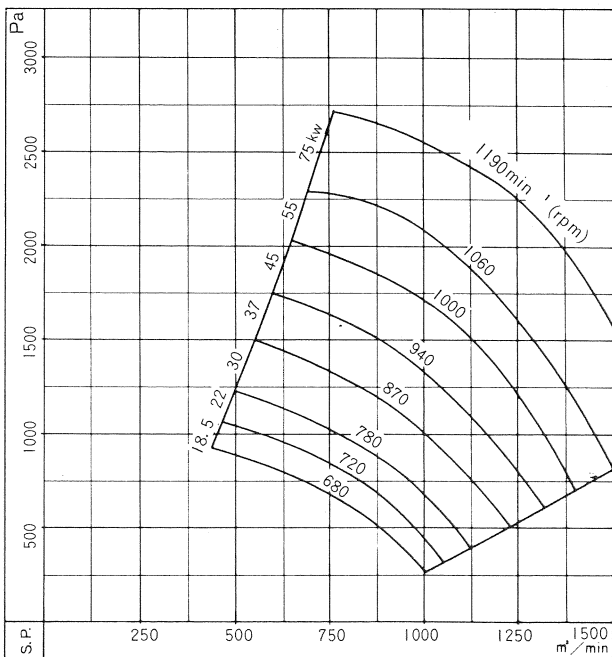

#9LS

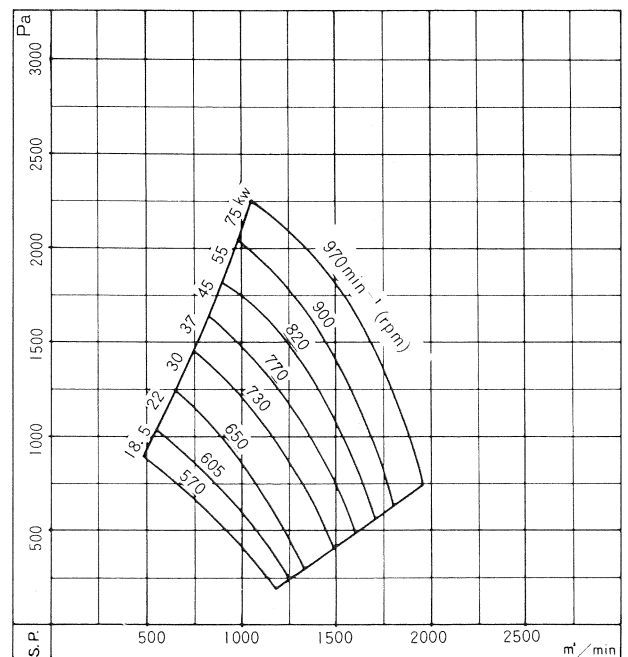

リミットロード送風機片吸込LS型

#10LS

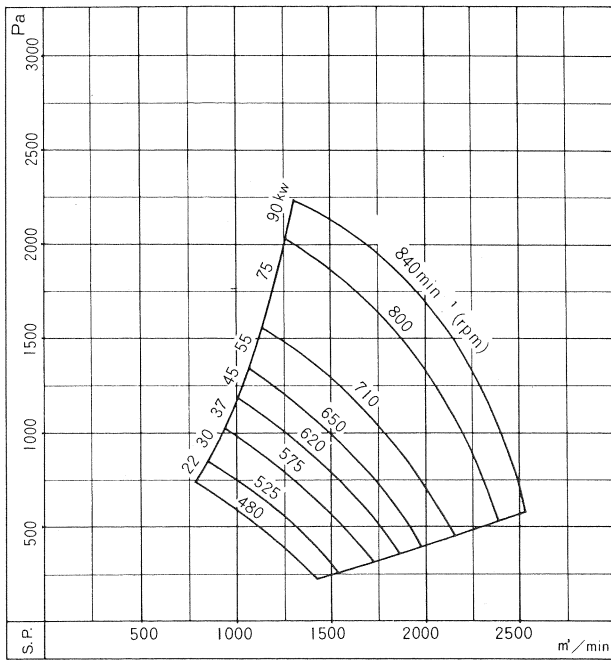

#11LS

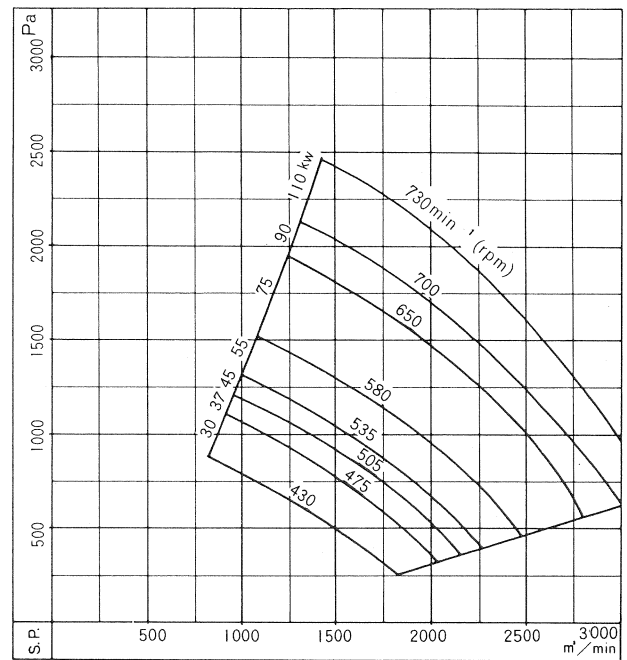

#12LS

